

online
THESLIDESHOP
DESIGNED TO DECORATE KIWI HOMES



PREMIUM
Wardrobe systems

THE SLIDE SHOP PRESENT

KIWI HOME NEVER OUT OF STYLE

- Specialize in wardrobe doors and cabinetry
- Built-in and walk-in wardrobes
- Wardrobe shelving and hangers have an array of combinations
- Our teams focus is on providing solutions to all your storage needs
- Functional, Stylish and ease is what we offer

www.theslideshop.co.nz



Introducing Stylish wardrobe designs, to suite your modern home.

Brought to you by the slide shop.

Our products meets international quality standard and with a variety of colours to match your décor, the mix between materials of Glass, Aluminum and Melamine creates a pleasing finish. (For more details please visit our website at www.theslideshop.co.nz)

The kitset is easily put together and comes with 10 years durability guarantees.



ALUMINUM DOORS

Our Heavy-duty aluminum door system is available in three exclusive styles with six colours to choose from.

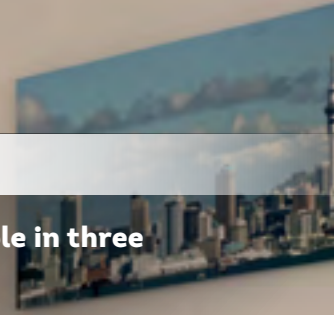

QUALITY WARDROBE SYSTEM

Special extruded aluminum with a hard PVC surface, there is also a selection of hanging options to provide a stylish and custom look to your wardrobe design.



SLIENTS TRACK SYSTEM

We offer Market Leading technology using an ultra quiet sliding track system that truly is amazing.



SPECIFICATION

- Market Leading design in door bumping system.
- Trendy wardrobe designs, not only beautiful but also very practical.
- All wardrobes are designed in line with the needs of New Zealanders.
- All wardrobes are built with 18mm MDF
- All panels have edge covering which prevent wear and tear and moisture damage to the MDF.
- All wardrobes are put together using a simple to use cam lock system, you can choose your custom shelving design to suit your needs.
- Easily adjustable in height.



• Perfect Combinations

• Superior Quality

• NZ Largest Product Range

DESIGNED to suit NZ BUILDING STANDARD

TYPICAL CROSS SECTIONS

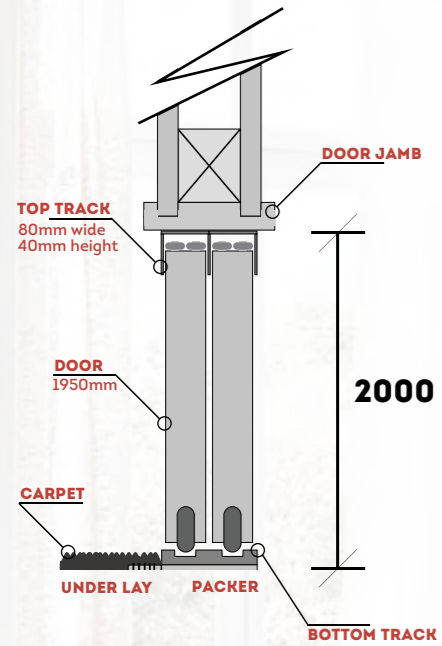

Carpet :
Use the packer provided with the trackset

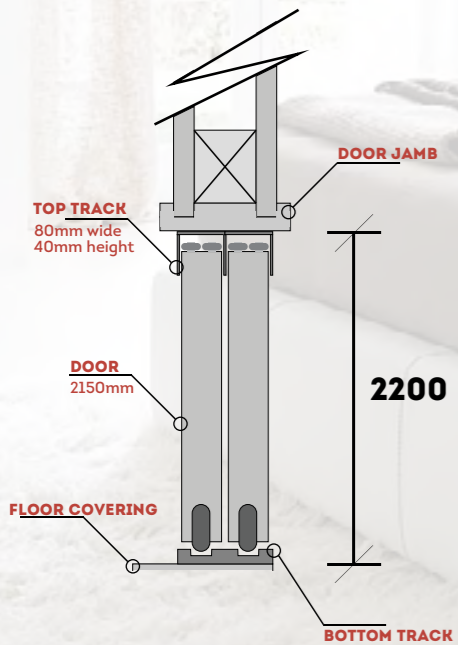

Floor Covering :
Place the track directly onto any type of floor covering

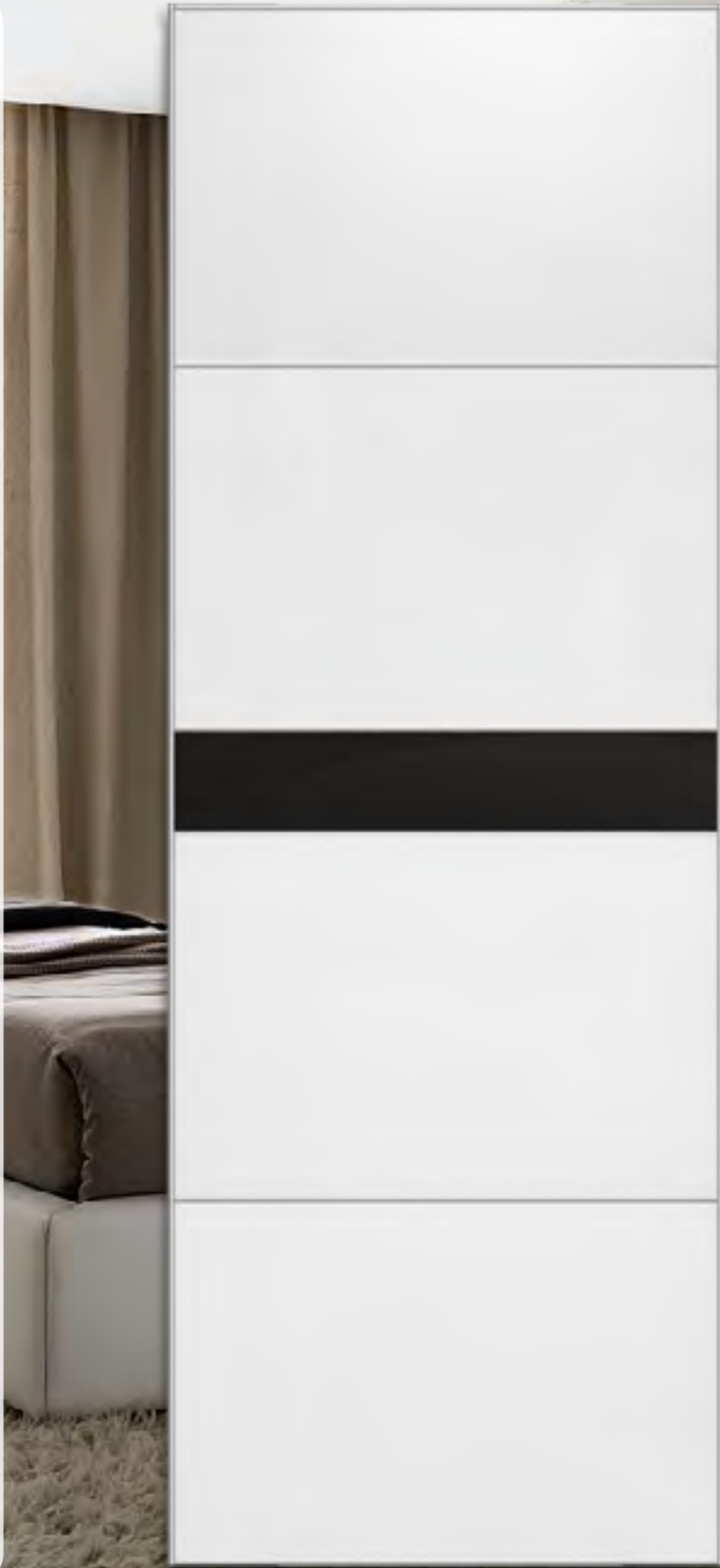

TYPICAL DOOR OVERLAY

2 Doors overlay = 1

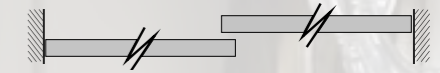

3 Doors overlay = 2

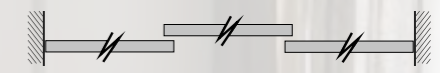

4 Doors overlay = 2

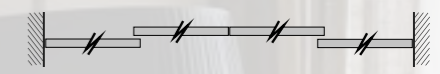

DOOR INSTALLATION GUIDE

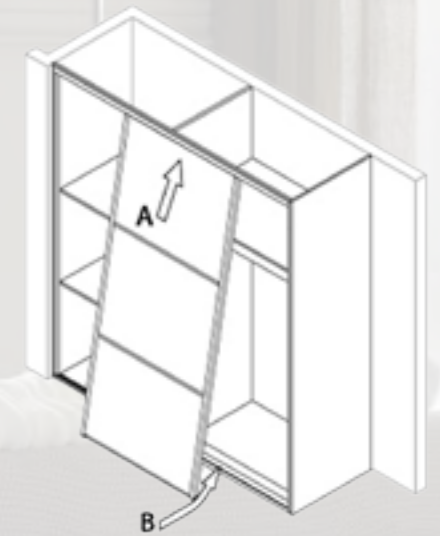

A : Push the door into the top track

B : Slide bottom of the door towards the bottom track

C : Level the doors by adjusting the wheels underneath



PRODUCT RANGE covers all BUILDING REQUIREMENT

Custom made on REQUEST

Price Match Guarantee.



NUMBER OF DOOR (mm)	OPENING HEIGHT (mm)	OPENING WIDTH (mm)	TRACK LENGTH (mm)
2 x 700	2000	1340	1400
2 x 900	2200	1740	1800
3 x 700	2000	1980	2100
3 x 900	2200	2580	2700











CURVE EDGE

65mm Frame

MATERIAL

- Melamine
- Mirror
- Bevel board
- UV board

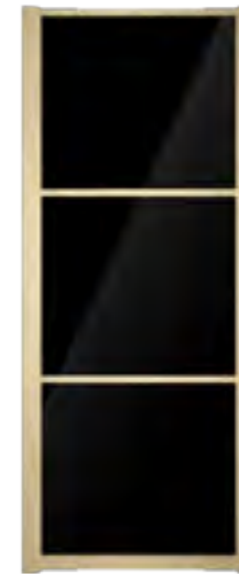
FOR MORE DETAILS PLEASE VISIT WWW.THESLIDESHOP.CO.NZ

<p>CODE CEBW - SW</p>  <p>FRAME COLOR Simple White PANEL STYLE Bevel board PANEL COLOR Simple White STOCK SIZE 700 x 1950 (mm)</p>	<p>CODE CEBM - MP</p>  <p>FRAME COLOR Maple PANEL STYLE Bevel board PANEL COLOR Maple STOCK SIZE 700 x 1950 (mm)</p>	<p>CODE CEMW - SW</p>  <p>FRAME COLOR Silver PANEL STYLE Safety Mirror PANEL COLOR Silver Mirror STOCK SIZE 700 x 1950 (mm) * Also available in White frame</p>	<p>CODE CEMM - GM</p>  <p>FRAME COLOR Maple PANEL STYLE Safety Mirror PANEL COLOR Grey Mirror STOCK SIZE 900 x 2150 (mm)</p>	<p>CODE CEF - GK</p>  <p>FRAME COLOR Silver PANEL STYLE Melamine PANEL COLOR Grey oak STOCK SIZE 700 x 1950 (mm)</p>
<p>CODE CEB - SW</p>  <p>FRAME COLOR Silver PANEL STYLE Melamine PANEL COLOR Simple White STOCK SIZE 700 x 1950 (mm)</p>	<p>CODE CEAW - SW</p>  <p>FRAME COLOR Simple White PANEL STYLE Melamine PANEL COLOR Simple White STOCK SIZE 700 x 1950 (mm)</p>	<p>CODE CEAM - HGW</p>  <p>FRAME COLOR Maple PANEL STYLE UV board PANEL COLOR High Gloss White STOCK SIZE 700 x 1950 (mm)</p>	<p>CODE CEB - MP</p>  <p>FRAME COLOR Maple PANEL STYLE UV board PANEL COLOR High Gloss Black STOCK SIZE 900 x 2150 (mm)</p>	<p>CODE CEB1W - SW</p>  <p>FRAME COLOR Simple White PANEL STYLE Large Bevel board PANEL COLOR Simple White STOCK SIZE 700 x 1950 (mm)</p>

Custom made on REQUEST

Price Match Guarantee.



NUMBER OF DOOR (mm)	OPENING HEIGHT (mm)	OPENING WIDTH (mm)	TRACK LENGTH (mm)
2 x 650	2000	1260	1300
2 x 850	2200	1630	1700
3 x 650	2000	1880	1950
3 x 850	2200	2480	2550

GROOVE

35mm Frame

MATERIAL

- Melamine
- Mirror
- Frost glass
- UV board

FOR MORE DETAILS PLEASE VISIT WWW.THESLIDESHOP.CO.NZ

CODE GRMS - SM



FRAME COLOR
Silver
PANEL STYLE
Safety Mirror
PANEL COLOR
Silver Mirror
STOCK SIZE
650 x 1950 (mm)

* Also available in White / Teak Frame

CODE GRF - SW



FRAME COLOR
Silver
PANEL STYLE
Melamine
PANEL COLOR
Simple White
STOCK SIZE
650 x 1950 (mm)

CODE GRF - TK



FRAME COLOR
Silver
PANEL STYLE
Melamine
PANEL COLOR
Teak
STOCK SIZE
650 x 1950 (mm)

CODE GR4B - FG



FRAME COLOR
Black
PANEL STYLE
Laminated Glass
PANEL COLOR
Opague
STOCK SIZE
850 x 2150 (mm)

CODE GR5B - GK/HGB

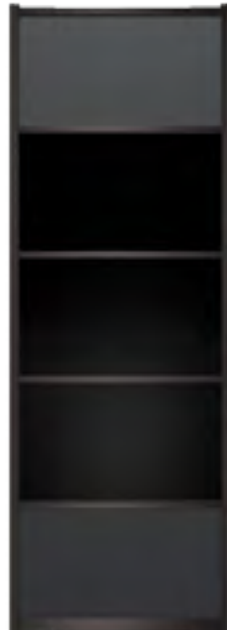

FRAME COLOR
Black
PANEL STYLE
Melamine & UV board
PANEL COLOR
Grey Oak & High Gloss Black
STOCK SIZE
850 x 2150 (mm)

CODE GR7B - MP



FRAME COLOR
Black
PANEL STYLE
PVC board & Black Trim
PANEL COLOR
Maple
STOCK SIZE
850 x 2150 (mm)

CODE GR7T - TK



FRAME COLOR
Teak
PANEL STYLE
PVC board & Black Trim
PANEL COLOR
Teak
STOCK SIZE
850 x 2150 (mm)

CODE GR3T - TK



FRAME COLOR
Teak
PANEL STYLE
Melamine
PANEL COLOR
Teak
STOCK SIZE
650 x 1950 (mm)

CODE GR4W - SW



FRAME COLOR
Simple White
PANEL STYLE
Melamine
PANEL COLOR
Simple White
STOCK SIZE
650 x 1950 (mm)

Custom made on REQUEST

Price Match Guarantee.



from
\$ 520
+ gst
3 Doors +
Trackset

All Prices available on
APP and Online

NUMBER OF DOOR (mm)	OPENING HEIGHT (mm)	OPENING WIDTH (mm)	TRACK LENGTH (mm)
2 x 600	2000	1200	1200
2 x 800	2200	1600	1600
3 x 600	2000	1800	1800
3 x 800	2200	2400	2400

SLIM LINE

10 mm Frame

MATERIAL

- Melamine
- Mirror
- Grid board
- UV board

FOR MORE DETAILS PLEASE VISIT WWW.THESLIDESHOP.CO.NZ

CODE SLW - SW



FRAME COLOR

Silver

PANEL STYLE

Grid board

PANEL COLOR

Simple White

STOCK SIZE

600 x 1950 (mm)

* Infill panel also available in Maple / Teak color

CODE SLA - SW



FRAME COLOR

Silver

PANEL STYLE

Melamine & Mirror

PANEL COLOR

White & Grey Mirror

STOCK SIZE

800 x 2150 (mm)

CODE SLA - TK



FRAME COLOR

Silver

PANEL STYLE

Melamine & Mirror

PANEL COLOR

Teak & Grey Mirror

STOCK SIZE

800 x 2150 (mm)

CODE SLM - SM



FRAME COLOR

Silver

PANEL STYLE

Safety Mirror

PANEL COLOR

Silver Mirror

STOCK SIZE

600 x 1950 (mm)

800 x 2150 (mm)

CODE SLM - GM



FRAME COLOR

Silver

PANEL STYLE

Safety Mirror

PANEL COLOR

Grey Mirror

STOCK SIZE

800 x 2150 (mm)

CODE SLT - HGW



FRAME COLOR

Silver

PANEL STYLE

UV board & Mirror

PANEL COLOR

High Gloss White & Grey Mirror

STOCK SIZE

800 x 2150 (mm)

CODE SLT - HGG



FRAME COLOR

Silver

PANEL STYLE

UV board & Mirror

PANEL COLOR

High Gloss Grey & Grey Mirror

STOCK SIZE

800 x 2150 (mm)

CODE SL4 - SW



FRAME COLOR

Silver

PANEL STYLE

Melamine

PANEL COLOR

Simple White

STOCK SIZE

600 x 1950 (mm)

CODE SL3 - GK



FRAME COLOR

Silver

PANEL STYLE

Melamine

PANEL COLOR

Grey Oak

STOCK SIZE

600 x 1950 (mm)

Cabinet⁺

CHOOSE A COLOR AND SEND US YOUR CUSTOM MEASUREMENTS. WE WILL DESIGN THE CABINET TO SUIT YOUR LIVING SPACE.

IF YOU HAVE A SMALL RENOVATION OR A MAJOR PROJECT, OUR TEAM CAN PROVIDE FREE DESIGN DRAWINGS TO MAKE YOUR DREAMS BECOME A REALITY.

HANGING RAIL

We offer two different types of hanging rails along with different hardware options; include high quality, heavy duty aluminum.

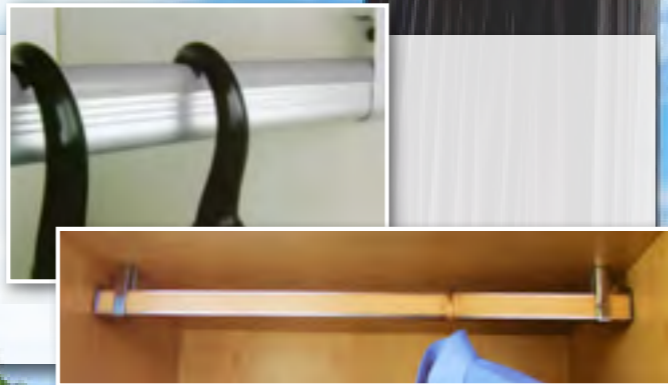

EDGING

Our 2mm thick edging on the mdf gives a trendy look, All broad are edged on all sides to prevent board from getting damaged if wet.



DRAWER TRACK

40KG Heavy-duty soft closing drawer runners, silent and high quality finish.



FLOOR PLAN

Use three doors for wardrobe from 1800 ~ 2800mm

Use two doors for wardrobe from 1300 ~ 1700mm

min. wardrobe depth 600mm

* Install wardrobe units prior to wall skirting.

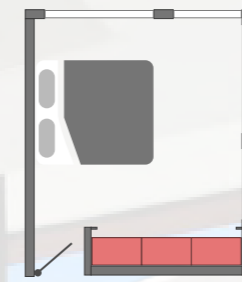

from
\$ 899
+ gst
3 x 600mm Unit
as shown

All Prices available on
APP and Online

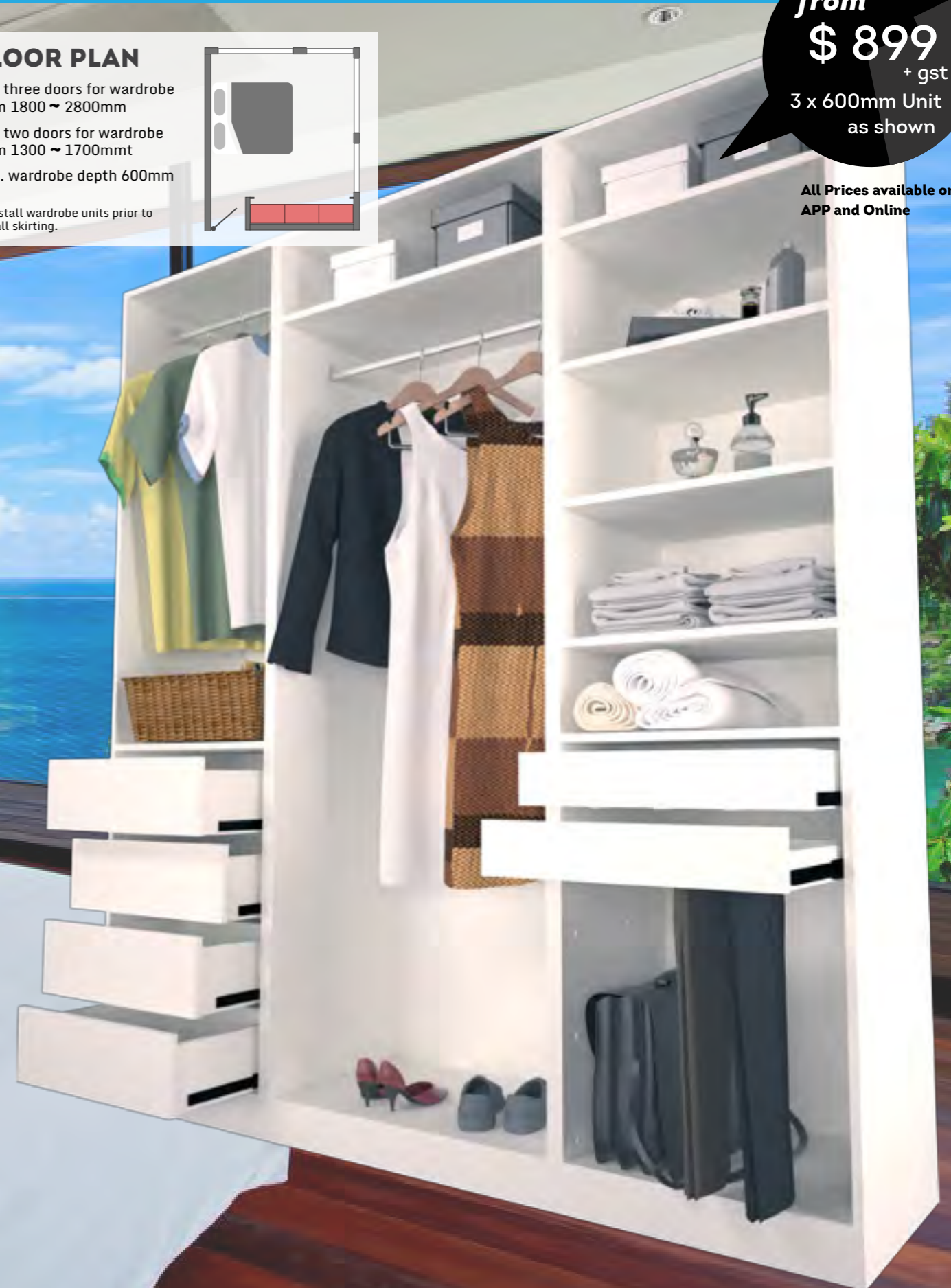

FLOOR PLAN

Standard wardrobe tower height 2200mm.

Standard Tower width 600 ~ 900 (mm)

Corner Tower width 900mm only

* Install wardrobe units prior to wall skirting.

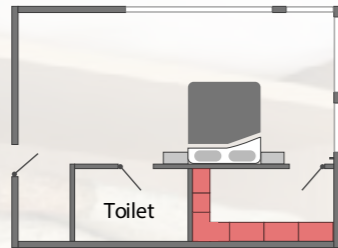

CORNER UNIT

Suitable for walk-in wardrobes, place this unit in the corner to make the best use of space. Available in 900mm x 900mm wide only.

All Prices Online

ACCESSORY DRAWER

Use this unit to store all kinds of accessories such as jewelry, ties, watches, keys and much more.

600 wide - 12 cubic
700 wide - 15 cubic
800 wide - 18 cubic
900 wide - 21 cubic

SMART SPACE

Another great idea to help organize your things smartly. Available in 600, 700, 800 and 900mm wide.

SHOE RACKS

Classy looking shoe shelves perfect for when you want to maximize your storage space. Shelves are available in 600, 700, 800 and 900 wide.

TROUSERS HANGING

Simply hang your trousers on this rack, separate your clothes and feel much more organized. Try our pull-out ironing board and other smart ideas.

Cabinet +

Wardrobe combination



3 Colors to choose

Teak

White

Grey Oak

DESIGN YOUR OWN COMBINATION

1500 mm width		1500 mm width		1600 mm width		1800 mm width		2400 mm width			1750 - 2950 mm width		
Tower		Tower		Tower		Tower		Tower			Tower		
WA-900 x 1	WA-600 x 1	WA-900 x 1	WB-600 x 1	WB-800 x 1	WB-800 x 1	WA-900 x 1	WB-900 x 1	WA-900 x 1	WA-600 x 1	WA-900 x 1	HU1200 x 2	WX-55 x 1	HU1200 x 1
Wardrobe accessories		Wardrobe accessories		Wardrobe accessories		Wardrobe accessories		Wardrobe accessories			Wardrobe accessories		
Hanging x 2	AS-600 x 5 SHS-600 x 2	Hanging x 2	AS-600 x 3 AD-600 x 1 TH-600 x 1	AS-800 x 1 Hanging x 1 AD-800 x 1 TH-800 x 1	AS-800 x 1 Hanging x 1 SD-800 x 4	AS-900 x 1 Hanging x 1 SMRT-900 x 1	AS-900 x 1 Hanging x 1 SD-900 x 2	AS-900 x 1 Hanging x 2	AS-600 x 5 SD-600 x 4	AS-900 x 1 Hanging x 1 SMRT-900 x 1	Hanging Wide 600 - 1200 (mm)	AS-550 x 5 SD-550 x 3	Hanging Wide 600 - 1200 (mm)

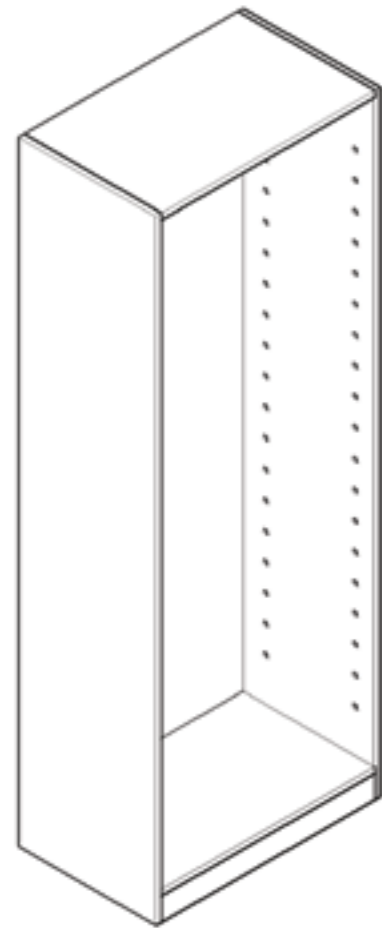

H	D	W (mm)
2200	490	600, 700, 800, 900

1. Adjustable holes
2. Back board included
3. Unscrew by using a screwdriver
4. All boards connect by cam-lock
5. Plan your storing needs and choose from item shown below
6. We can assemble the tower unit and also the accessory fitted prior to delivery.

Mix and Match options

Smart Space



Adjustable Shoe Shelve



Adjustable Shelf



Clothes Hanging

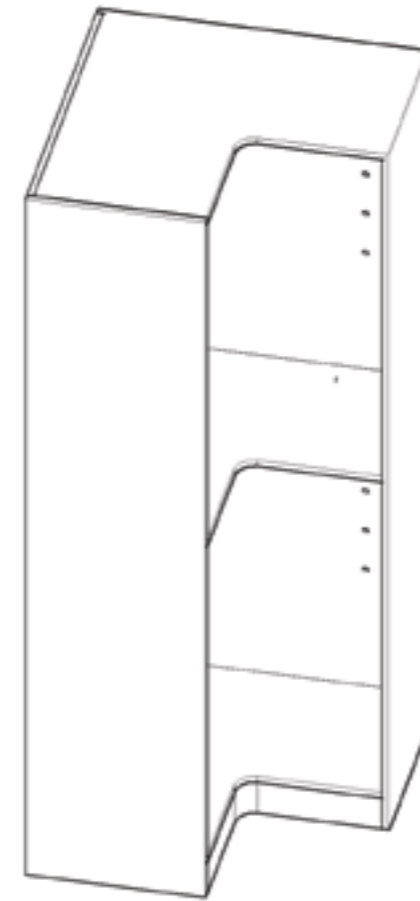

H	D	W (mm)
2200	490	900

1. Adjustable holes
2. Back board included
3. Unscrew by using a screwdriver
4. All boards connect by cam-lock
5. Plan your storing needs and choose from item shown below
6. We can assemble the tower unit and also the accessory fitted prior to delivery.

Mix and Match options

Corner Hanging



Adjustable Shelve

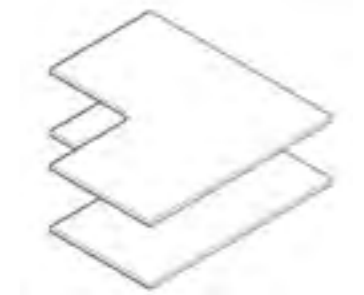

Clothes Hanging

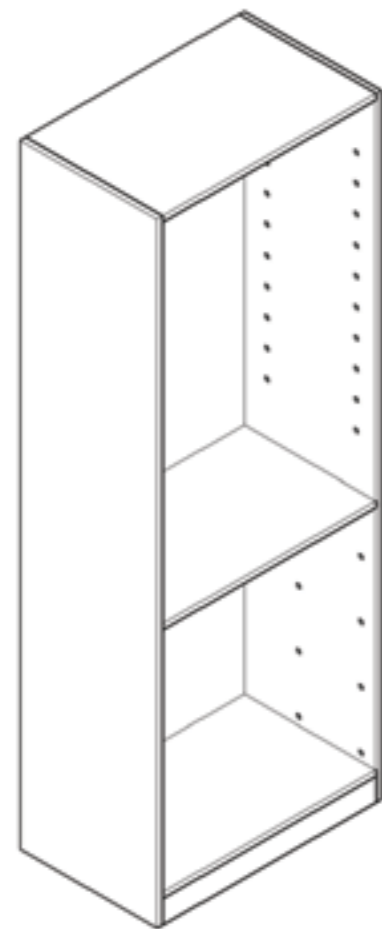

H	D	W (mm)
2200	490	600, 700, 800, 900

1. Adjustable holes
2. Back board included
3. Unscrew by using a screwdriver
4. All boards connect by cam-lock
5. Plan your storing needs and choose from item shown below
6. We can assemble the tower unit and also the accessory fitted prior to delivery.

Mix and Match options

Smart Space



Standard Drawer

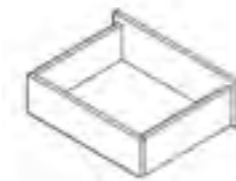

Drawer with Aluminum handle

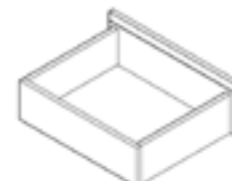

Adjustable Shelf



Thousers Hanging



Accessory Drawer

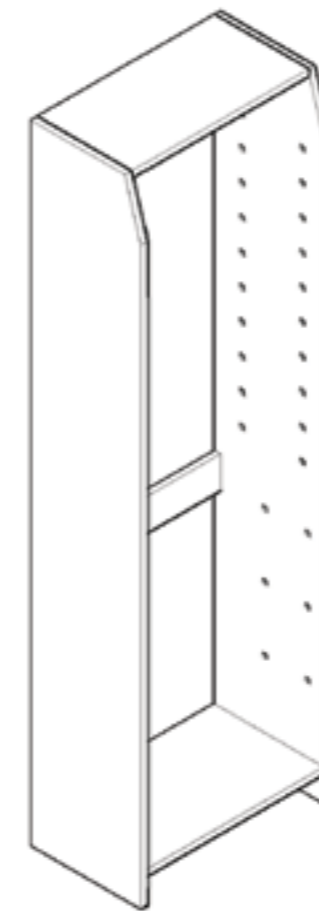

H	D	W (mm)
2000	350	550

1. Adjustable holes
2. Back board included
3. Unscrew by using a screwdriver
4. All boards connect by cam-lock
5. Plan your storing needs and choose from item shown below
6. We can assemble the tower unit and also the accessory fitted prior to delivery.

Mix and Match options

Standard Drawer

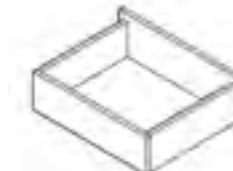

Hanging Unit

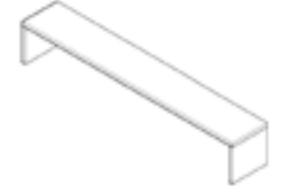

Adjustable Shelf



Clothes Hanging



2 types of Hanging Rail to Choose from

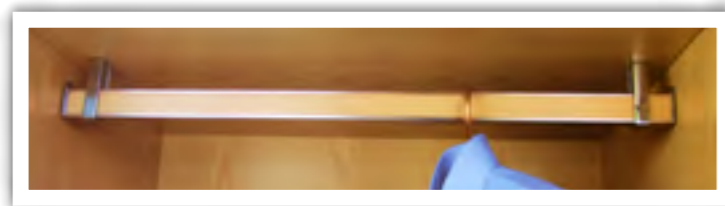

Code PA12D
Size 600~1100mm
Finish Aluminum / PVC

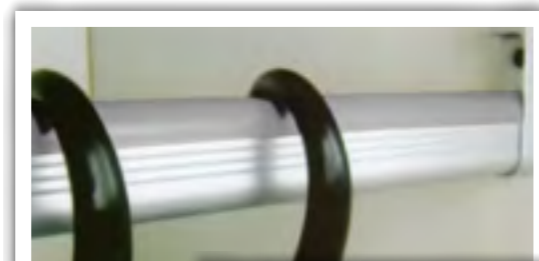

Code PA12A
Size 600~1100mm
Finish Aluminum

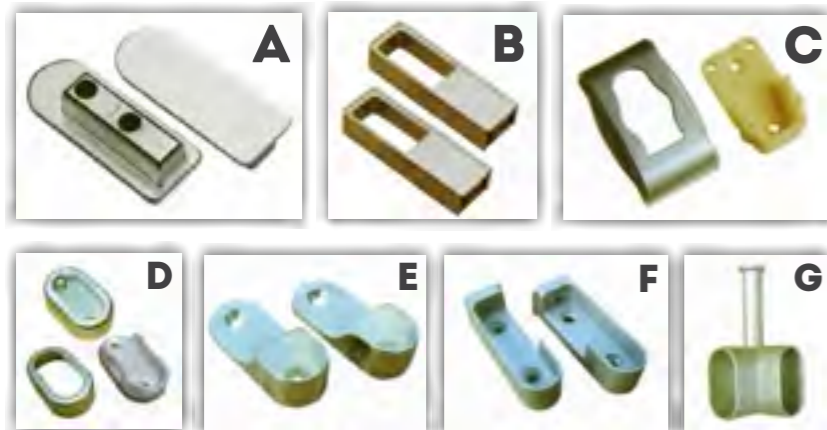

	CODE	FINISH
A	PA11F	Satin
B	PA11E	Satin
C	PA11G	Silver Grey
D	PA11C	Silver Grey
E	PA11A	Satin
F	PA11B	Satin
G	PA11D	Satin



HOLD UP TO 40KG



Code PA14
Finish Chrome



Code PA08 PA06B
Size 240mm(D) 250mm(D)
Finish Black Silver



Code PA019
Color Silver, Gold
Finish Aluminum

Premium ACCESSORY

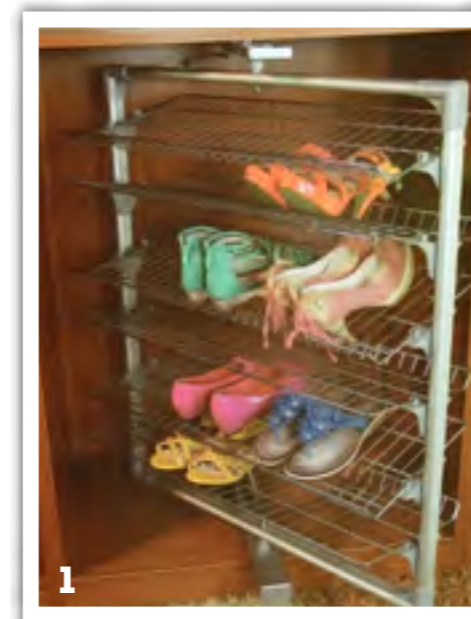

1



2

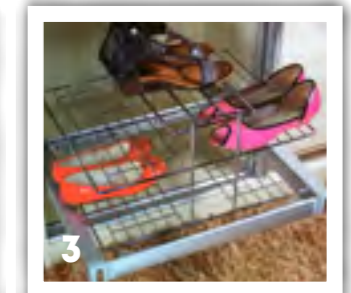

3

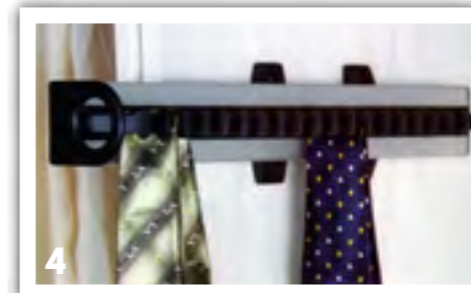

4

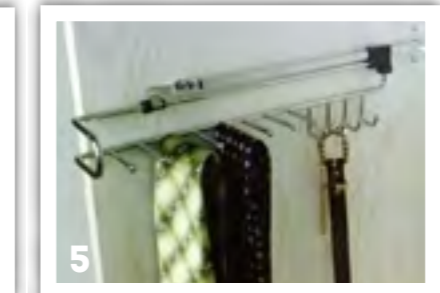

5



6

	CODE	SIZE	FINISH
1	PA-6A	6 Layers 750mm wide	Chrome
2	PA203	600mm wide 800mm wide	Anodise / Wood
3	PA207	600mm wide	Chrome
4	PA007	410mm wide	Anodise
5	PA07B	400mm wide	Chrome
6	PA014B	460mm wide	Anodise
7	PA029A	350x135x1340 mm	Brushed

DESIGNED to
fit into our standard wardrobe unit



7

Ordering Process

1. Email us (or send us your file links) your floor plans and we will get in touch shortly after.
2. Browse our website and place order on items selected.
3. Call us on 09 415 5681 and speak to one of our friendly staff



Nationalwide Delivery Option

A . FLAT PACK B . ASSEMBLED



A



B

Product Installation



We can arrange product installation Auckland wide

Contact Detail



Website



Office



Mobile



E Mail

theslideshow.co.nz

09 415 5681

021 288 0990

info@theslideshow.co.nz



Location



Media

Showroom detail on website



Localist



Facebook



Trademe